

GaAs PHEMT MMIC LOW NOISE HIGH IP3 AMPLIFIER, 12 - 17 GHz

Typical Applications

The HMC490 is ideal for use as either a LNA or driver amplifier for:

- Point-to-Point Radios
- Point-to-Multi-Point Radios
- VSAT
- Military & Space

Functional Diagram

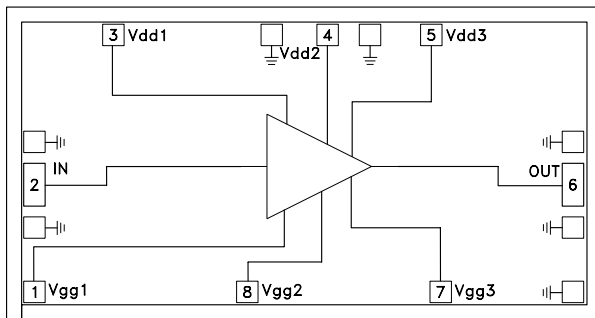

Features

- Noise Figure: 2 dB
- +26 dBm P1dB
- Gain: 27 dB
- +35 dBm Output IP3
- +5V Supply
- 50 Ohm Matched Input/Output

General Description

The HMC490 is a high dynamic range GaAs PHEMT MMIC Low Noise Amplifier which operates between 12 and 17 GHz. The HMC490 provides 27 dB of gain, 2 dB noise figure and an output IP3 of 35 dBm from a +5.0 V supply voltage. The amplifier chip can easily be integrated into Multi-Chip-Modules (MCMs) due to its small size. All data is tested with the chip in a 50 Ohm test fixture connected via 0.025mm (1 mil) diameter wire bonds of minimal length 0.31mm (12 mils).

Electrical Specifications, $T_A = +25^\circ C$, $V_{dd} = 5V$, $I_{dd} = 200 mA^*$

| Parameter | Min. | Typ. | Max. | Min. | Typ. | Max. | Units |
|---|---------|------|---------|------|------|------|-------|
| Frequency Range | 12 - 14 | | 14 - 17 | | | | GHz |
| Gain | 24 | 26.5 | | 24 | 27 | | dB |
| Gain Variation Over Temperature | | 0.03 | 0.04 | | 0.03 | 0.04 | dB/°C |
| Noise Figure | | 2.5 | | | 2.0 | | dB |
| Input Return Loss | | 8 | | | 12 | | dB |
| Output Return Loss | | 8 | | | 9 | | dB |
| Output Power for 1 dB Compression (P1dB) | 22 | 25 | | 23 | 26 | | dBm |
| Saturated Output Power (Psat) | | 27 | | | 28 | | dBm |
| Output Third Order Intercept (IP3) | | 32 | | | 35 | | dBm |
| Supply Current (I _{dd})(V _{dd} = 5V, V _{gg} = -0.8V Typ.) | | 200 | | | 200 | | mA |

* Adjust V_{gg} between -2.0 to 0V to achieve I_{dd} = 200 mA typical.

GaAs PHEMT MMIC LOW NOISE HIGH IP3 AMPLIFIER, 12 - 17 GHz

Broadband Gain & Return Loss

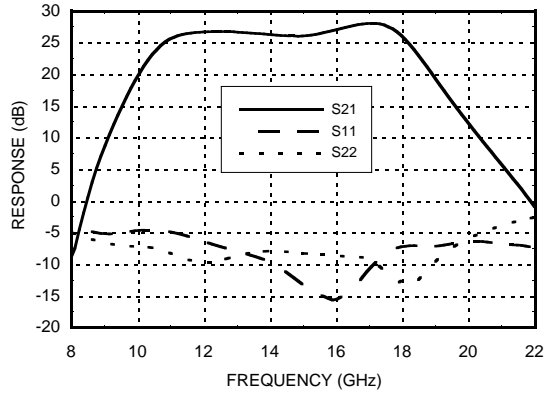

Gain vs. Temperature

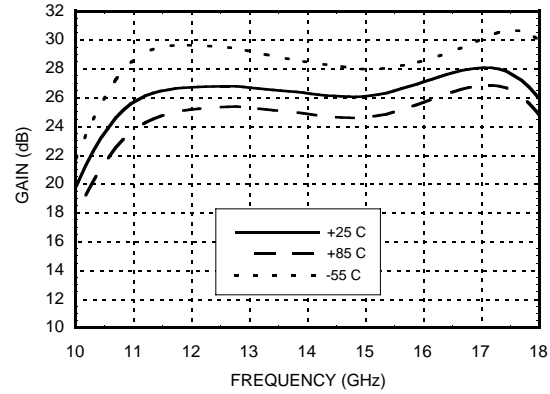

Input Return Loss vs. Temperature

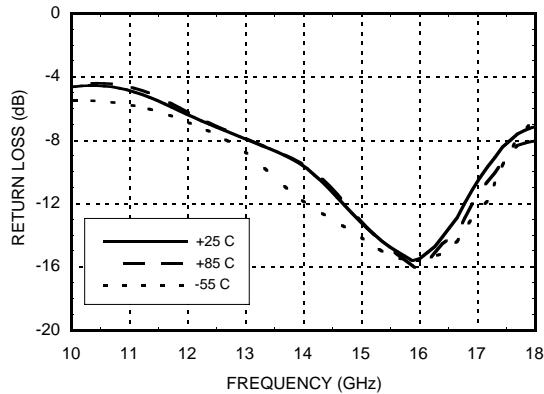

Output Return Loss vs. Temperature

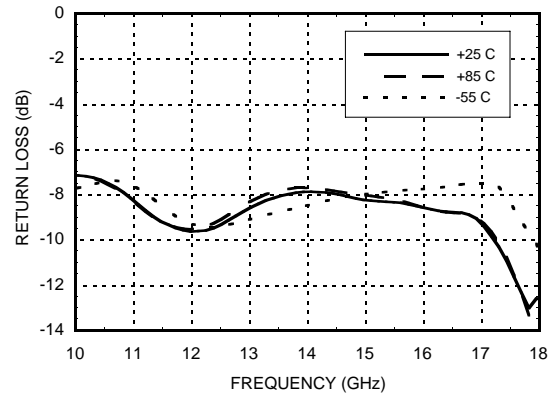

Noise Figure vs. Temperature

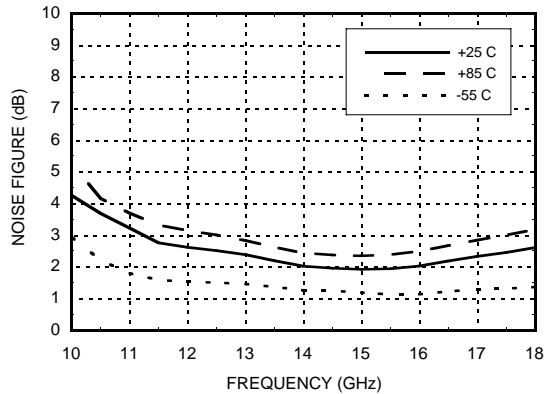

Output IP3 vs. Temperature

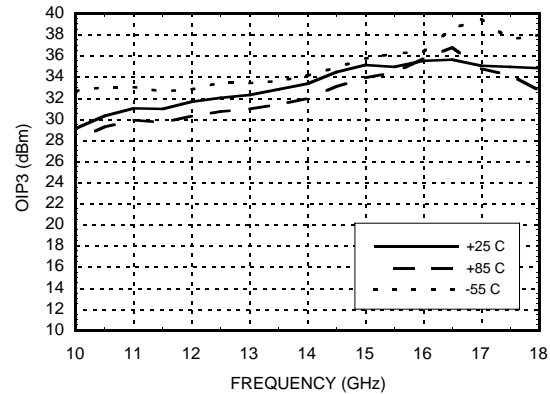

GaAs PHEMT MMIC LOW NOISE HIGH IP3 AMPLIFIER, 12 - 17 GHz

1

AMPLIFIERS - CHIP

P1dB vs. Temperature

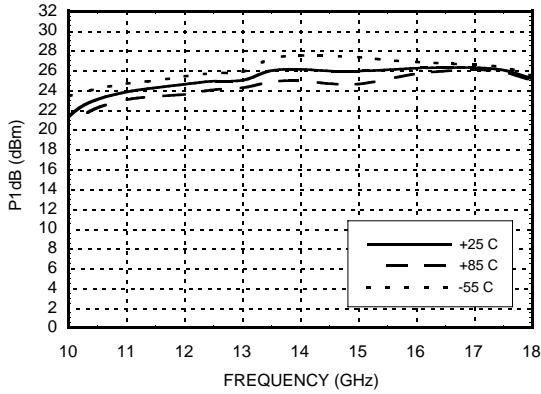

Psat vs. Temperature

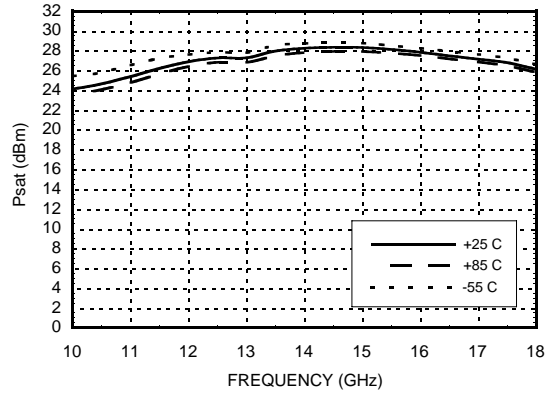

Gain & Noise Figure vs. Supply Voltage @ 14 GHz, I_{dd}= 200 mA

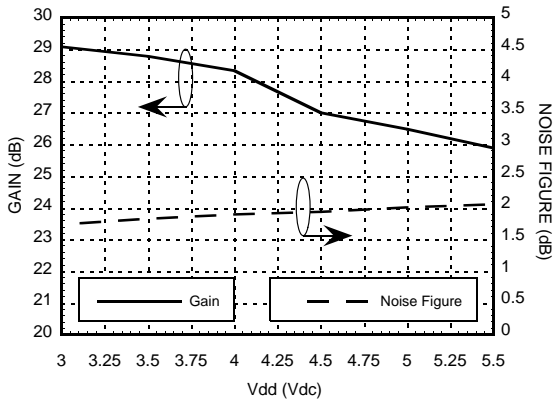

Power Compression @ 14 GHz

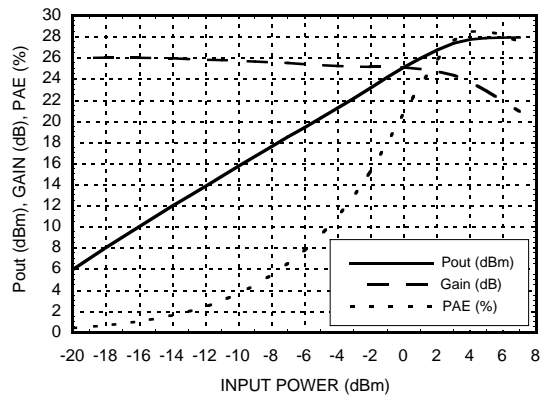

Reverse Isolation vs. Temperature

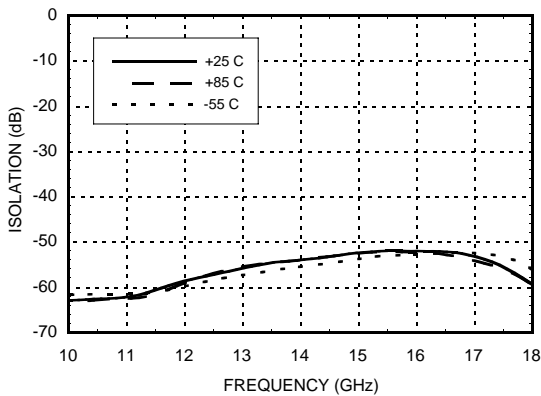

Gain, Noise Figure & IP3 vs. Supply Current @ 14 GHz, V_{dd}= 5V*

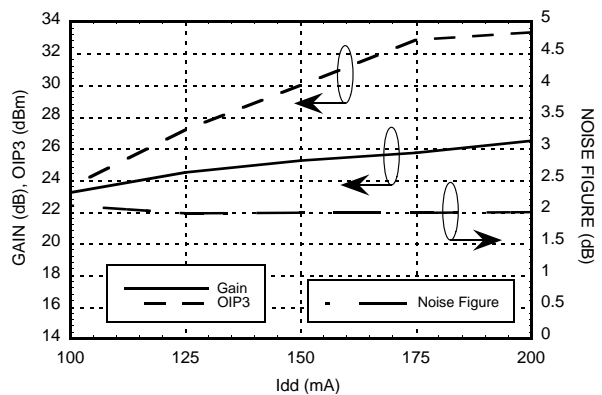

* I_{dd} is controlled by varying V_{gg}

GaAs PHEMT MMIC LOW NOISE HIGH IP3 AMPLIFIER, 12 - 17 GHz

Absolute Maximum Ratings

| | |
|--|----------------|
| Drain Bias Voltage (Vdd1, Vdd2, Vdd3) | +5.5 Vdc |
| Gate Bias Voltage (Vgg1, Vgg2, Vgg3) | -4.0 to 0 Vdc |
| RF Input Power (RFIn)(Vdd = +5.0 Vdc) | +10 dBm |
| Channel Temperature | 175 °C |
| Continuous P _{diss} (T= 85 °C) (derate 29 mW/°C above 85 °C) | 2.65 W |
| Thermal Resistance (channel to die bottom) | 34 °C/W |
| Storage Temperature | -65 to +150 °C |
| Operating Temperature | -55 to +85 °C |

Typical Supply Current vs. Vdd

| Vdd (Vdc) | I _{dd} (mA) |
|-----------|----------------------|
| +4.5 | 191 |
| +5.0 | 200 |
| +5.5 | 208 |
| +3.0 | 189 |
| +3.5 | 200 |
| +4.0 | 208 |

Note: Amplifier will operate over full voltage ranges shown above. V_{gg} adjusted to achieve I_{dd}= 200 mA at +5.0V and +3.5V.

Outline Drawing

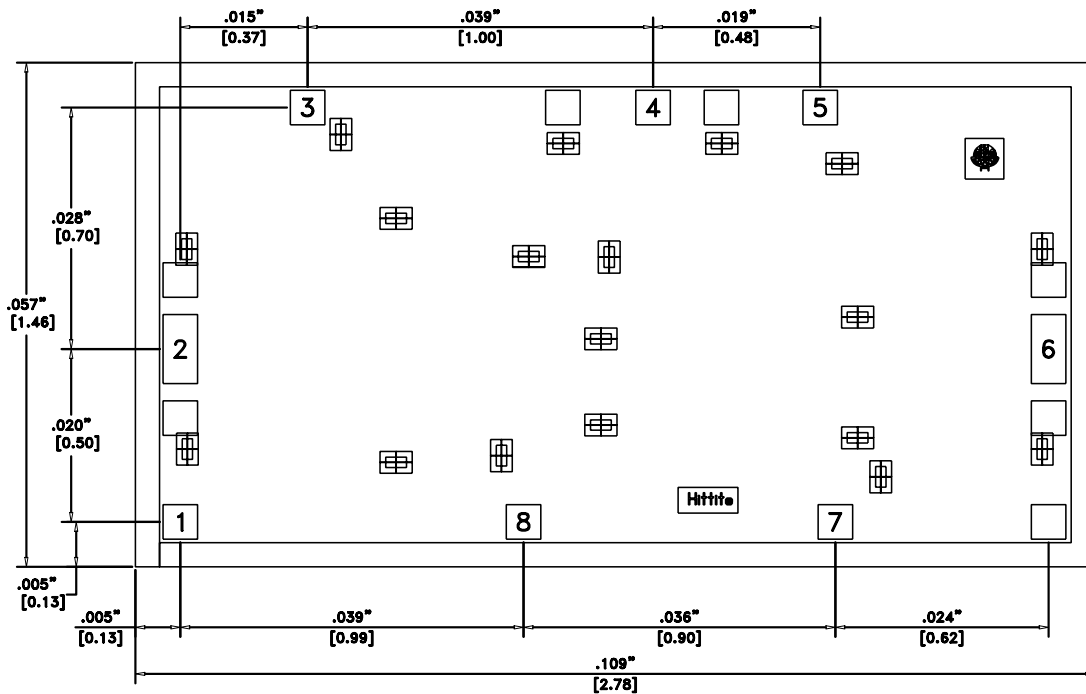

NOTES:



1. ALL DIMENSIONS ARE IN INCHES [MM]
2. DIE THICKNESS IS .004"
3. TYPICAL BOND IS .004" SQUARE
4. BACKSIDE METALLIZATION: GOLD
5. BOND PAD METALLIZATION: GOLD
6. BACKSIDE METAL IS GROUND.
7. CONNECTION NOT REQUIRED FOR UNLABELED BOND PADS.

For price, delivery, and to place orders, please contact Hittite Microwave Corporation:
 12 Elizabeth Drive, Chelmsford, MA 01824 Phone: 978-250-3343 Fax: 978-250-3373
 Order Online at www.hittite.com

GaAs PHEMT MMIC LOW NOISE HIGH IP3 AMPLIFIER, 12 - 17 GHz

1

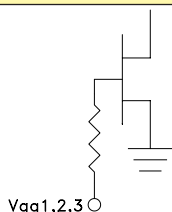
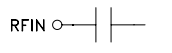
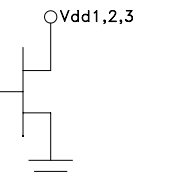
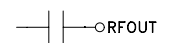
Pad Descriptions

| Pin Number | Function | Description | Interface Schematic |
|------------|------------|---|---|
| 1, 8, 7 | Vgg1, 2, 3 | Gate control for amplifier. Adjust to achieve Id of 200 mA. Please follow "MMIC Amplifier Biasing Procedure" Application Note. External bypass capacitors of 100 pF and 0.01 μF are required. |  |
| 2 | RF IN | This pad is AC coupled and matched to 50 Ohms from 12 - 17 GHz. |  |
| 3, 4, 5 | Vdd1, 2, 3 | Power Supply Voltage for the amplifier. External bypass capacitors of 100 pF and 0.01 μF are required. |  |
| 4 | RF OUT | This pad is AC coupled and matched to 50 Ohms from 12 - 17 GHz. |  |
| Die Bottom | GND | Die Bottom must be connected to RF/DC ground. |  |

**GaAs PHEMT MMIC LOW NOISE
HIGH IP3 AMPLIFIER, 12 - 17 GHz**

Assembly Diagram

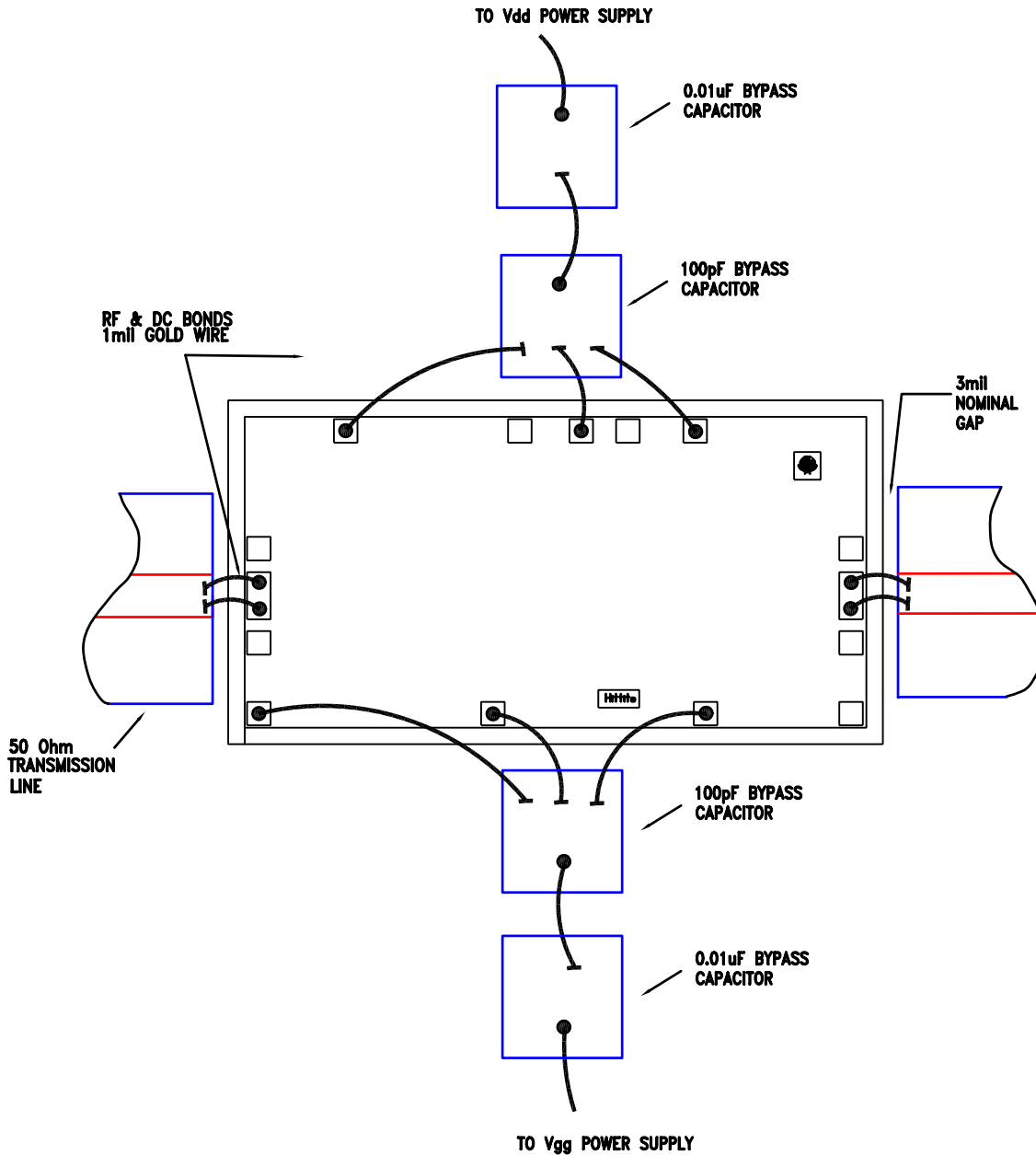

GaAs PHEMT MMIC LOW NOISE HIGH IP3 AMPLIFIER, 12 - 17 GHz

1

Mounting & Bonding Techniques for Millimeterwave GaAs MMICs

The die should be attached directly to the ground plane eutectically or with conductive epoxy (see HMC general Handling, Mounting, Bonding Note).

50 Ohm Microstrip transmission lines on 0.127mm (5 mil) thick alumina thin film substrates are recommended for bringing RF to and from the chip (Figure 1). If 0.254mm (10 mil) thick alumina thin film substrates must be used, the die should be raised 0.150mm (6 mils) so that the surface of the die is coplanar with the surface of the substrate. One way to accomplish this is to attach the 0.102mm (4 mil) thick die to a 0.150mm (6 mil) thick molybdenum heat spreader (moly-tab) which is then attached to the ground plane (Figure 2).

Microstrip substrates should be brought as close to the die as possible in order to minimize bond wire length. Typical die-to-substrate spacing is 0.076mm to 0.152 mm (3 to 6 mils).

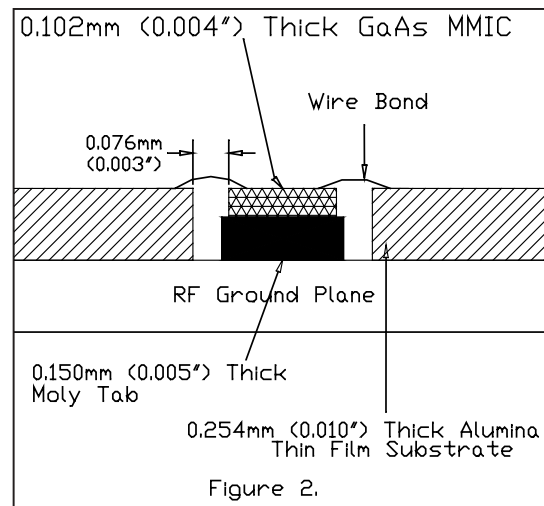
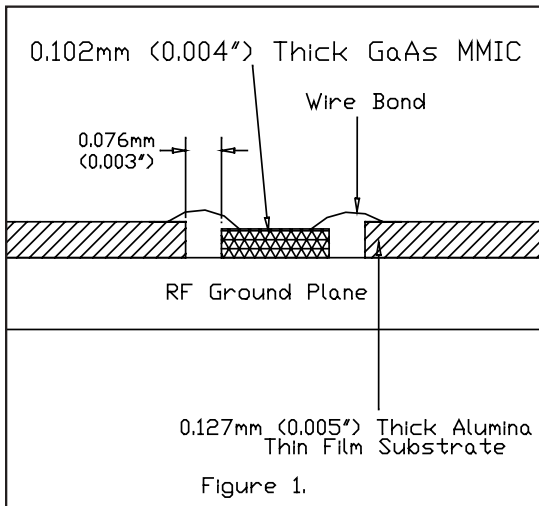

**GaAs PHEMT MMIC LOW NOISE
HIGH IP3 AMPLIFIER, 12 - 17 GHz****Handling Precautions**

Follow these precautions to avoid permanent damage.

Cleanliness:

Handle the chips in a clean environment.
DO NOT attempt to clean the chip using liquid cleaning systems.

Static Sensitivity:

Follow ESD precautions to protect against $> \pm 250V$ ESD strikes.

Transients:

Suppress instrument and bias supply transients while bias is applied.
Use shielded signal and bias cables to minimize inductive pick-up.

General Handling:

Handle the chip along the edges with a vacuum collet or with a sharp pair of bent tweezers.
The surface of the chip has fragile air bridges and should not be touched with vacuum collet, tweezers, or fingers.

Mounting

The chip is back-metallized and can be die mounted with AuSn eutectic preforms or with electrically conductive epoxy.
The mounting surface should be clean and flat.

Eutectic Die Attach:

A 80/20 gold tin preform is recommended with a work surface temperature of 255 deg. C and a tool temperature of 265 deg. C. When hot 90/10 nitrogen/hydrogen gas is applied, tool tip temperature should be 290 deg. C.
DO NOT expose the chip to a temperature greater than 320 deg. C for more than 20 seconds. No more than 3 seconds of scrubbing should be required for attachment.

Epoxy Die Attach:

Apply a minimum amount of epoxy to the mounting surface so that a thin epoxy fillet is observed around the perimeter of the chip once it is placed into position.
Cure epoxy per the manufacturer's schedule.

Wire Bonding

Ball or wedge bond with 0.025 mm (1 mil) diameter pure gold wire. Thermosonic wirebonding with a nominal stage temperature of 150 deg. C and a ball bonding force of 40 to 50 grams or wedge bonding force of 18 to 22 grams is recommended. Use the minimum level of ultrasonic energy to achieve reliable wirebonds.

Wirebonds should be started on the chip and terminated on the package or substrate. All bonds should be as short as possible < 0.31 mm (12 mils).